

User Manual

MODEL: QM 500

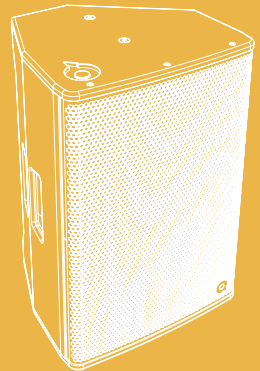

Contents

Safety Precautions	1
When Installing the Unit	2
When the Unit is in Use	2
General Description	3
QM Range Optional Accessories	3
Functional Design	3
Getting The Best From Your QM500	4
Connections	4
Suitable Amplification	4
Speaker cables	5
Speaker Placement as a Single Box or in Arrays	5
Flying the QM500	6
Rotating the Horn Flare	6
Foldback HF coverage	6
QM500 Wave Guide Examples	7
QM500 Specifications	8
Technical Parameters	8
QM500 Reference Diagram	9
Tech Tips and Troubleshooting	10
Mixer Basics	10
Input Gain Settings	10
Powering up the PA system	11
Buzzes and Noises in the Sound System?	11

Safety Precautions

- Be sure to read the instructions in this section carefully before use.
- Make sure you observe the instructions in this manual as the conventions of safety symbols and messages are very important.
- We also recommend you keep this instruction manual handy for future reference.

Safety Symbol and Message Conventions

Safety symbols described below are used in this manual to prevent bodily injury and property damage which could result from mishandling. Before operating your product, read this manual first and understand the safety symbols and messages so you are thoroughly aware of any risks.



WARNING

Indicates a potentially hazardous situation which, if mishandled, could result in death or serious personal injury.





WARNING

When Installing the Unit

- Do not expose the unit to rain or an environment where it may be exposed to water or other liquids, as doing so may result in damage to the bass driver or corrosion of the steel protective grill.
- Do not cut, kink, otherwise damage nor modify the speaker cable. Also use speaker cable of at least 1.5mm core diameter. In addition, avoid locating the speaker cables close to heaters, high traffic areas or locations where the cables can be damaged.
- Avoid installing or mounting speaker boxes in unstable locations and when flying, use the hardware designed for the speaker box and fix securely to a solid wall. Failing to do so may result in the unit falling, causing personal injury and/or property damage.
- Be sure to ground to the safety ground (earth) terminal to avoid electric shock. Never ground to a gas pipe as a catastrophic disaster may result.
- Never hang a speaker box from only one rigging point. Use multiple points and attach a safety line to a point strong enough to take the weight of the speaker box.

When the Unit is in Use

- Turn down the amplifier before switching on the amplifier. If there is no sound, check the speaker connections. Speaker connectors must be locked in place.
- Should any of the following irregularities be found during use, immediately switch off the amplifier power, disconnect the power supply plug from the AC outlet and contact your nearest Quest dealer:
 - If you detect smoke or a strange smell coming from the unit,
 - If the unit falls and the unit case is damaged,
 - If it is malfunctioning (no HF or low frequency output).

Make no further attempt to operate the unit if it is found to be in any of the above conditions as this may cause fire or electric shock.

2



WARNING

Flying the box from one insert must not be attempted!
Improper installation may result in damage, injury or death.

General Description

The QM500 is a passive two way bass reflex design speaker suitable for mobile or installation use. The design characteristics of the QM500 make it suitable for both full range use or as the high-mid component of a multi way system with sub-bass enhancement.

The patented phase device high frequency transducer is matched to a rotatable asymmetrical wave guide that can be rotated through 270 degrees for horizontal, vertical or fold-back monitor installation.

The asymmetrical coverage allows the horn to achieve both long throw performance and wide angle close coverage without "hot zones" or adding to unnecessary room reflections that can degrade vocal intelligibility. The unit can be used in a stand alone configuration or as part of a system coupled with any Quest sub-bass system. When used in conjunction with these devices, the QM500 will form part of a high performance multi way audio system.

Installation

Temporary installation is possible with the 35mm floor stand mounting in the base of the enclosure. Fold-back installation can give extra uniform stage performance by rotating the horn flare to the "fold-back" position.

Five M10 thread inserts are located on the speaker, 2 at the top, 2 on one side of the speaker, and a last one at the bottom. they allow stand-alone applications, as well as the mounting of accessories. These are intended to be used with the WB500 wall bracket.

Functional Design

The QM500 casing features an asymmetrical horizontal angle along one side which makes it suitable for use as a stage/foldback wedge.

The painted ply casing has steel reinforced polymer skids to help protect the paintwork and adhere to the stage floor without sliding around during the performance. The heavy gauge power-coated steel grill ensures the driver and horn are always protected.

3

Getting The Best From Your QM500

Connections

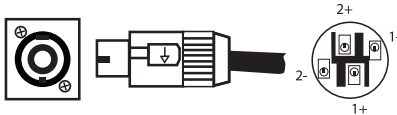

Two Neutrik™ Speakon model NL-4 connectors are mounted in a removable panel on the rear surface of the box.

The connector input is wired pin 1+ and pin 1-. Pin 2 is not connected.

Take care when inserting the Speakon connector twisting the connector until it locks into place. Reverse the procedure to disconnect.

Suitable Amplification

The QM500 is an 8 ohm enclosure and can be connected in multiple parallel connections to an amplifier channel that can operate at speaker impedances of 4 ohms.

The QM500 is a mid power level high efficiency system, so ultra high power is not necessary to obtain high sound pressure levels. The recommended power range per amplifier channel is 350 - 500 watts RMS into an 8 ohm load or up to 1,000W RMS into a 4 ohm load. An ideal partner to the QM500 are any of the Quest QA range of amplifiers. Setting the QA amplifier's high pass filter at 35Hz is recommended for full range applications. If you are intending to add sub bass speakers, the high pass filter can be set to 80Hz.

4

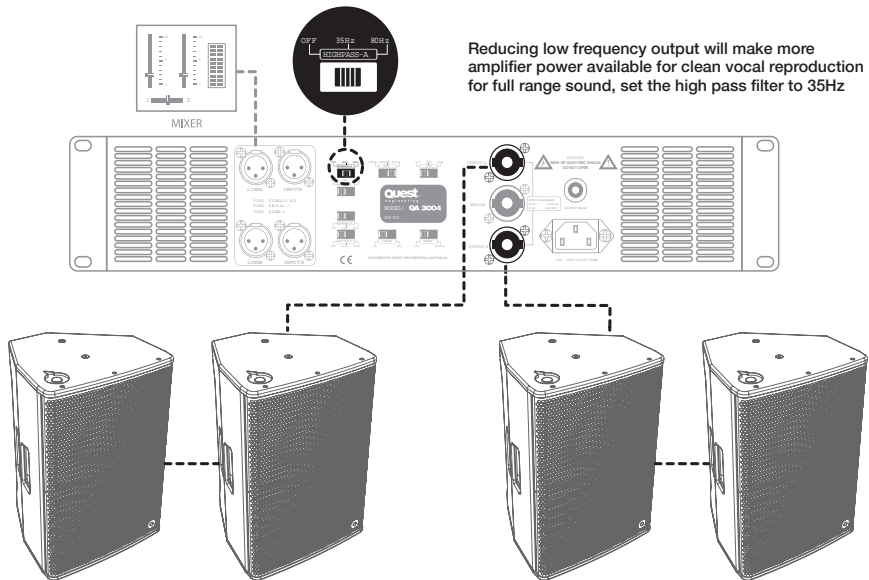

**Recommended QM500
Amplifier Configuration**

Speaker cables

Speaker cable needs to be as heavy gauge as conveniently possible for low-loss results. Light gauge cable (below 1.5mm) will create extra resistance and waste amplifier power. This particularly applies to long speaker runs. The amplifier’s damping factor statistic (“punch” for the non technical) is greatly diminished, so keep your speaker cables short and as heavy gauge as practical.

Speaker Placement as a Single Box or in Arrays

The QM500 is intended for use as a single speaker system or as part of a multiple speaker setup with or without sub bass reinforcement. It can also be installed in small arrays of up to three boxes per array for very wide coverage applications.

When a group of point source speaker boxes are placed together, it is possible to have “interference effect” between some of the boxes causing uneven frequency response. This can be particularly noticeable in the mid-high frequency area.

If you intend to set up the QM500 as part of a multiple box array, see the section ‘Flying the QM500’.

When positioning the speaker system on a stage, make sure the HF horn at the top of the speaker box is above the heads of the audience. At full power the output of the QM500 is very high and hearing damage can result from short to medium term exposure.

For best results when the QM500 is used as a front of house speaker, the HF horn should be aimed away from the ceiling and focused on the intended area of coverage. This will minimize HF reflections, lower the reverberant field in the room and give better intelligibility.

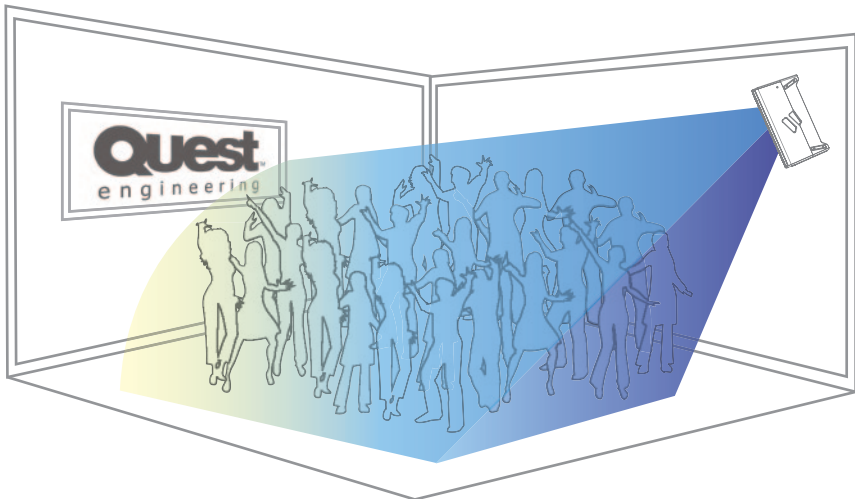

Ideal QM500 Flown Configuration to benefit from the asymmetrical HF coverage

Flying the QM500

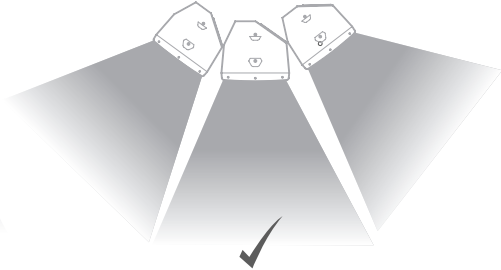
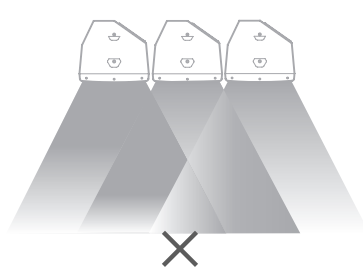

Before suspending any speaker system always inspect all components (enclosure, rigging frames, track fittings, etc.) for cracks, deformations, corrosion, missing, loose or damaged parts that could reduce strength and safety of the array. Do not suspend the speaker system until the correct preparation of the installation site has been taken to avoid health risks during and after the completion of the installation. A licensed Professional Engineer must approve the placement and method of attachment to the structure prior to the installation of any overhead object.

vertically), the asymmetrical horn should be used as supplied and will not need to be rotated.

For horizontal installation rotate 45 degrees so the arrow is pointing at the floor side so as to have the “beaming” facility at the top of the horn.

Foldback HF coverage

For stage foldback monitors the coverage must be wide when performers are close to the wedge and beam down the stage to minimize the spill off the stage that may interfere with the main PA.

For floor monitor use the horn must be rotated with its “wide” dispersion (arrow indicator), side directed towards the top of the horizontal floor cabinet.

When removing and reinstalling the front grill to rotate the horn, ensure the nuts are not over tightened as this may make them difficult to remove in future or cause them to break.

Rotating the Horn Flare

The asymmetrical horn flare can be rotated through three separate planes of dispersion depending on the speaker box requirement and installation environment. The planes are vertical installation, horizontal installation and foldback monitor.

Good coverage of audiences often requires wide dispersion at the base of the horn flare to cover close listeners and a focused narrow dispersion at the top of the flare to beam to the back of the room.

The QM500 horizontal horn covers both “short-throw” and “long-throw” requirements in a single system. For the majority of installations (where the box is installed



WARNING

Ensure the box is securely located. If any doubt about the physical stability, tie the box down with ratchet straps to a secure base.

QM500 Wave Guide Examples

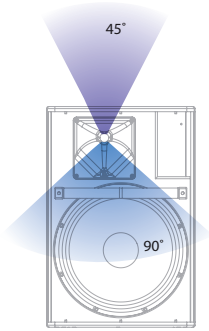

QM500 FOH Configuration (front)

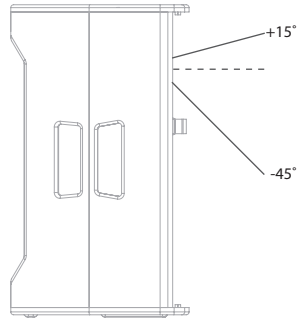

QM500 FOH Configuration (side)

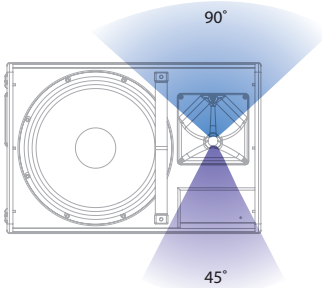

QM500 Foldback Configuration (front)

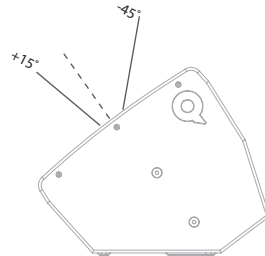

QM500 Foldback Configuration (side)

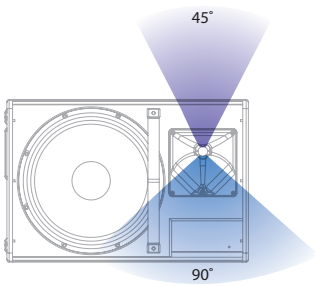

QM500 Horizontal Configuration (front)

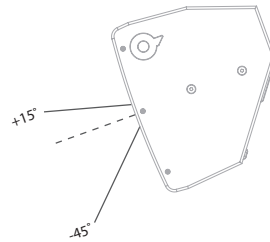

QM500 Horizontal Configuration (side)

QM500 Specifications

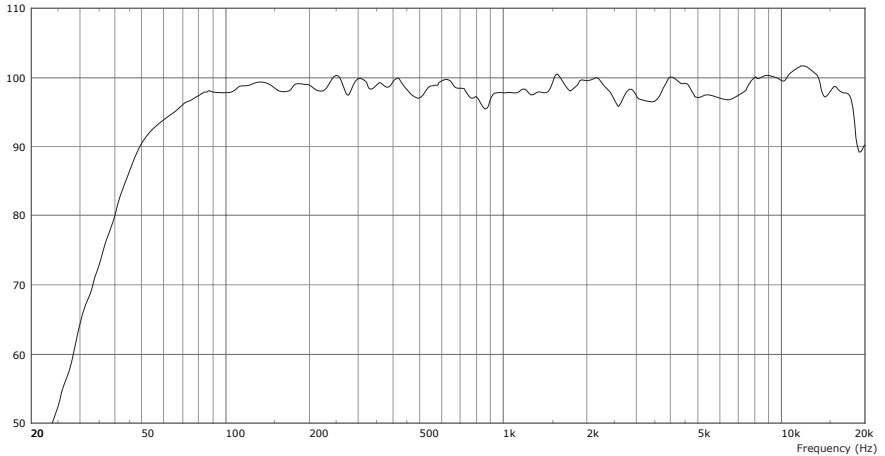

Technical Parameters

Power Handling	500W program , 1000W peak
Frequency Response	55-18kHz (+/-3dB)
Sensitivity	98dB @ 1kHz
Maximum SPL @ 1m	128dB
Woofers	15" Medium Power Bass Woofer
Tweeter	1" Ferrite Compression Driver
Directivity	Asymmetric +15/-45 ; 45/60 horizontal
Dimensions	647 x 432 x 369.5 mm
Weight	24 kg Net

QM500 Reference Diagram

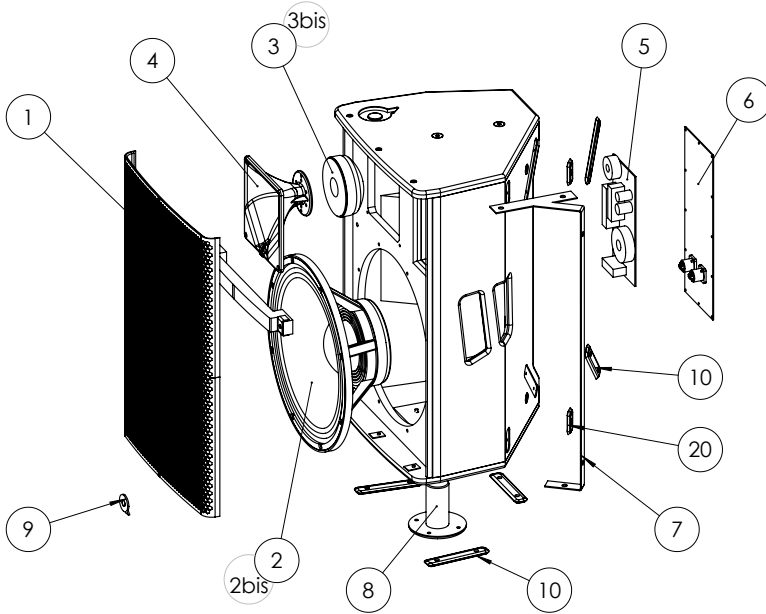

9

No.	Description	Spare Part
1	Complete Grill (with Acoustic Foam)	HGQM500
2	15" Woofer (3" voice-coil, 350Wrms, 8ohms)	T15004
2bis	Recone kit to suit 15" woofer	RT15004
3	Compression Driver 1" exit (1.75"voice-coil, 75Wrms, 8ohms)	T1012
3bis	Compression driver recone (diaphragm)	RT1012
4	Asymmetric horn flares - for 1" driver	HWG350
5	Passive filter network (complete) - X-over	AXQM500
6	Back connection panel	HCPQM500
7	Internal metal brace	HIBQM500
8	Top hat plate	HTHP2
9	Rotating Q badge (35mm)	HQB25
10	Rubber skids (medium)	HSK137
11	Rubber skids (small)	HSK52

Tech Tips and Troubleshooting

You can never know too much when it comes to the variety of technical issues that can appear at your gig. Here are a few tips.

Mixer Basics

Whether you are starting with one microphone two turntables and an iPod, or a 48 channels of live band, the audio principles are the same. If you introduce distortion to any part of the audio chain, it will still be there at the end of the line (your speakers).

A small audio system may only be a sound source, a mixer and a amplifier/speaker combination. A slightly bigger one may have added to the chain, DI boxes, digital effects, compressors, equalizers and electronic cross-overs. Any of these units that have excessive input level will pass on distortion to all the following equipment in the chain. It follows that all the individual units must have their input and output levels operating within their designed operational range.

A mixer output meter that is showing +9 dB at the end of the "red bars", only to be pushing a compressor/limiter to limit 10dB is only going to sound bad, not get louder. When you look at a Vu meter on a mixer (Vu means voltage units), you will see a row of numbers with a minus (-) sign in front of them leading to a "0dB" on the right hand side.

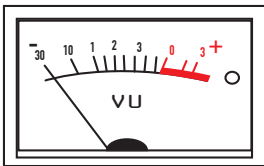

When the gain structure chain is set correctly, "0" means you have the system full power (not including any "head room" the system may have). After "0" db, you are reaching the limits of the system's capacity to deliver undistorted sound. How much distortion

will depend on a number of factors, but it is enough to say that by the time you get to the end of the red, your mixer is now clipping and sooner or later you are likely to damage the loudspeakers.

Input Gain Settings

Channel input levels must be set to prevent a mixer channel overloading during the performance. Too high a setting will introduce distortion at the start of the signal chain.



10

Powering up the PA system

It is wise to avoid switching on or off devices in the signal path while the speaker system is powered and turned up. Otherwise loud clicks and bangs could result. When shutting down the system, always turn the speakers off first. This is to prevent the speaker amplifying the sound of the other equipment in the chain being shut down. The reverse is true when powering up. Mixers and effects on first, power amplifiers or powered speakers on last.

Buzzes and Noises in the Sound System?

This is a specialised study in itself but as an introduction, here's a few tips.

BUZZ

Sometimes you can experience a hum and buzz together. A buzz is almost always a problem with the "earthing" of the system. It will often occur when you have the system powered from separate power outlets in the same building or audio and lighting sharing a common power circuit.

Even when the audio and lighting systems are powered from separate sources, there can still be a common earth between them. For example, a smoke machine may be powered from the lighting system, yet the trigger mechanism could be connected to the audio system through the audio multi-core/snake.

An earth connection between the audio and lighting will now exist and a buzz could be amplified in the audio system. The simple solution is to power your audio circuit and everything connected to it from the same source. If the buzz persists, check your signal cables, one may have an earth/shield disconnected. A cheap but possibly life

saving investment is a domestic power tester to check that the power supply sockets are correctly wired. Faulty or incorrectly wired power is a booby trap that is more common than you think.

WHITE NOISE

This is the hiss that suggests that the gain structure is set incorrectly. Something in the signal chain is boosting too much or an input is set too sensitive. If your equipment has gain switches on it, set them all the same. If the switch is labelled +4dB, set them all to that figure. If one piece of equipment seems to be overloading, set them all to -10/-20dB and be prepared to boost the input level of the QSA input. The last unit in the chain should be set to +4 dB at the output stage if possible when connected to the line level input of the QSA series input.

CHECK THE POWER

A cheap but possibly life saving investment is a domestic power tester to check that the power supply sockets are correctly wired. Faulty or incorrectly wired power is a booby trap that is more common than you think.

READ THE WARNINGS!

All audio products are sold with instruction manuals and this is where the important safety and user information is found. Always read and follow the safety directions. All manuals for Quest products can be downloaded from the internet at the following address:

www.questaudio.net/downloads/

We love receiving your gig stories and photos and we welcome comments and "war stories" from Quest users. Contact: info@questaudio.net



Register Your Product

Thank you for choosing Quest. Please take the time to complete your product registration card which is included with the packaging.

Registering your Quest Engineering product will:

- CONFIRM YOUR WARRANTY
- REGISTER YOUR PRODUCT
- PROTECT YOUR NEW PRODUCT

REGISTER ONLINE:

www.questaudio.net/registration

quest[™]
engineering

www.questaudio.net